



Hi Fly Kites
P.O. Box 827, Howick 3290
Woodgrove Farm No. 22, D 795 Road, Merrivale 3291
KwaZulu-Natal, South Africa

Tel: 033-330 5746 (Intl: +27-33-330 5746)
Fax: 033-330 5746 (Intl: +27-33-330 5746)
URL: www.hiflykites.co.za



AIRPORT WINDSOCK 1.23m (4ft)

A true Airport Windssock. 1.23m (4ft) long.

Made from strong nylon.

The Airport Windssock is often chosen by companies for customised designs (logo printed on the windssock).

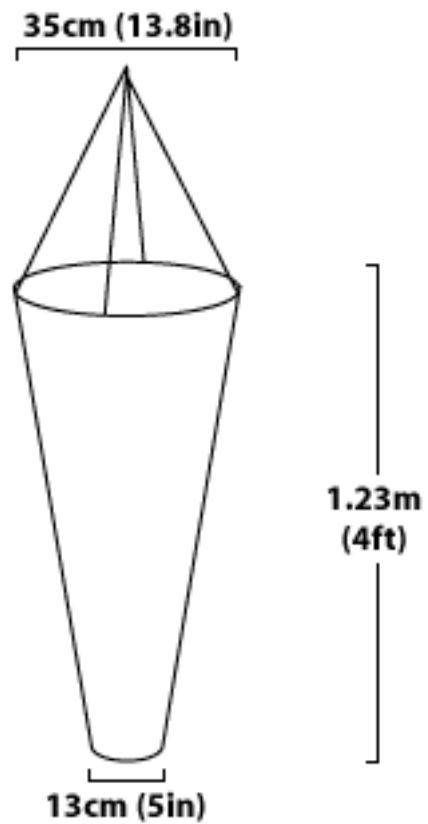

Colour Styles

Colours that you see might vary from the real ones due to various screen settings on different computers. To see the colour codes and their descriptions click [here](#).

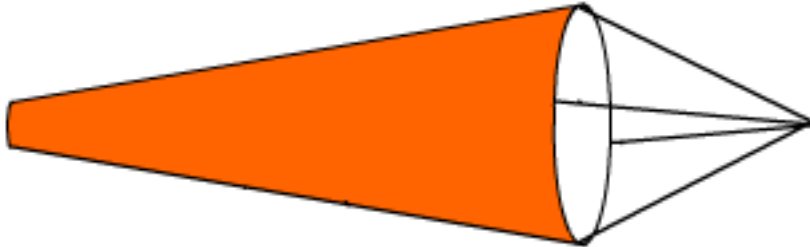

Style 1

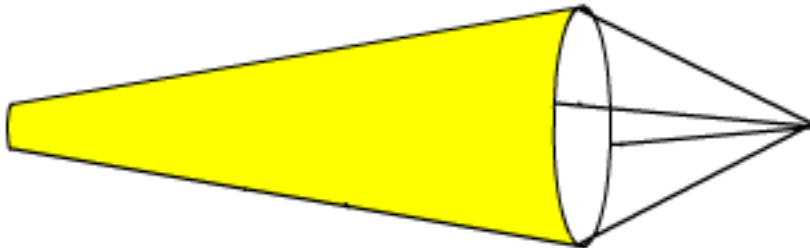

Style 2

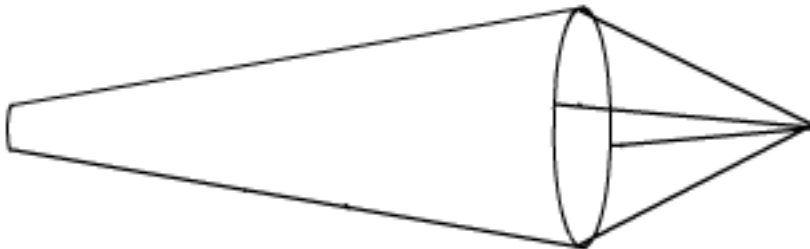

Style 3

Pictures of Airport Windsock



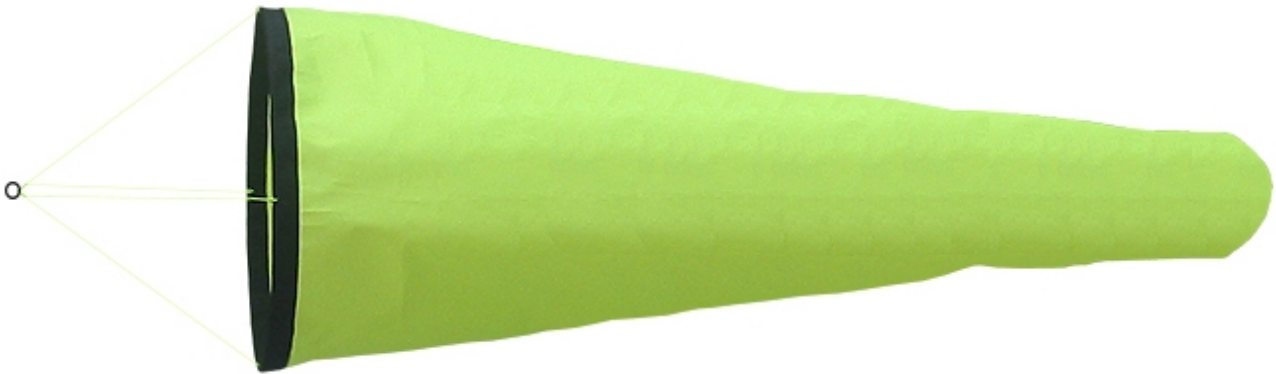











You can buy an Airport Windsock online right now at www.hiflykites.co.za. See you there!



Colour Names, Codes and References

The page contains the closest references to the fabric colours used by Hi Fly Kites. Please note that the fabrics are semi-transparent and the colour perception is different in daylight or artificial light. The page is best viewed in 32-bit (true colour) screen settings.

Swatch	Colour Name	Hi Fly Kites Code	R	G	B	Hue	Sat	Lum	Value (HEX)
	Black	bl	0	0	0	160	0	0	000000
	Bright Blue	bb	3	158	192	127	233	92	039EC0
	Cerese	ce	254	62	97	233	238	149	FE3E61
	Green	gr	84	217	141	97	153	142	54D98D
	Jade	ja	0	123	118	118	240	58	007B76
	Petunia	pe	186	76	106	229	106	123	BA4C6A
	Purple	pu	116	65	118	198	70	86	744176
	Orange	or	254	51	43	2	238	140	FE332B
	Red	re	254	5	0	1	240	120	FE0500
	Royal Blue	rb	58	57	119	161	85	83	3A3977
	Yellow	ye	253	231	80	35	235	157	FDE750
	White	wh	255	255	255	160	0	240	FFFFFF