



Hi Fly Kites
P.O. Box 827, Howick 3290
Woodgrove Farm No. 22, D 795 Road, Merrivale 3291
KwaZulu-Natal, South Africa

Tel: 033-330 5746 (Intl: +27-33-330 5746)
Fax: 033-330 5746 (Intl: +27-33-330 5746)
URL: www.hiflykites.co.za

Embark on an adventure, fly a kite, ride the wind and let your spirit soar...



SKYMONSTER (Single Line Kite)

A patented delta sled designed for kite aerial photography and falcon training where good lift and stability is required.

Carbon fibre frame. Can be adjusted to tack into wind.

A smaller version of Skymonster - Skymaster - has a dowel frame.

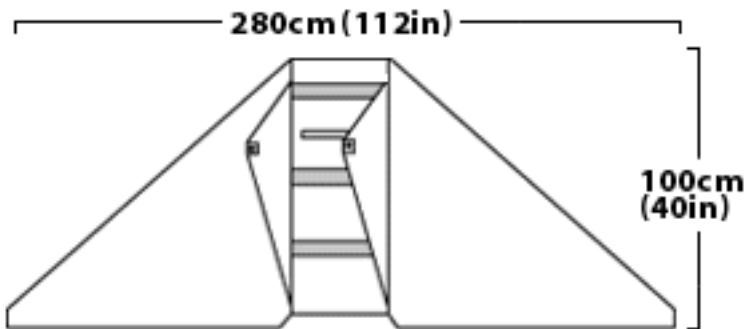

Front view - panels

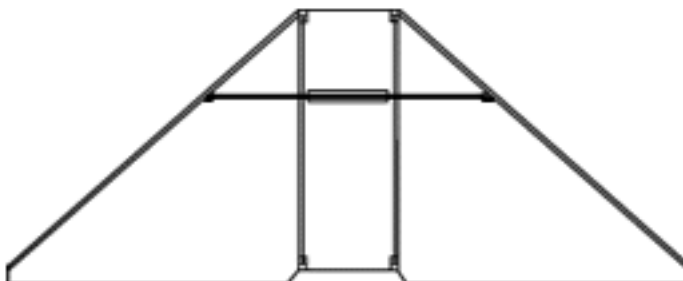

Back view - framework

All our kites come ready to fly!



Colour Styles

Colours that you see might vary from the real ones due to various screen settings on different computers. To see the colour codes and their descriptions click [here](#).

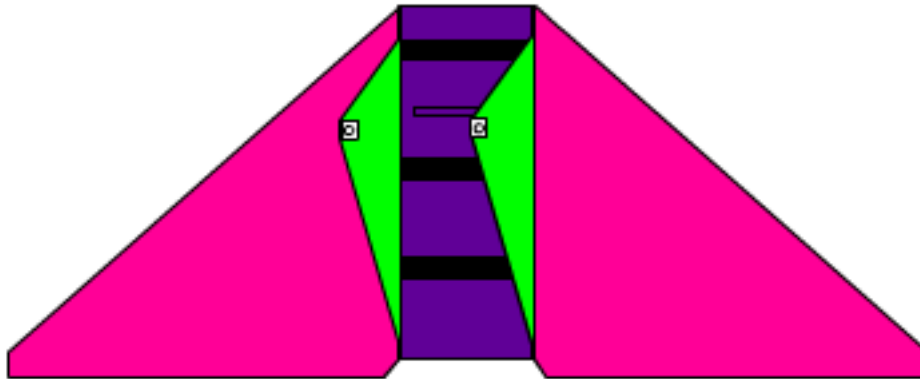

Style 1

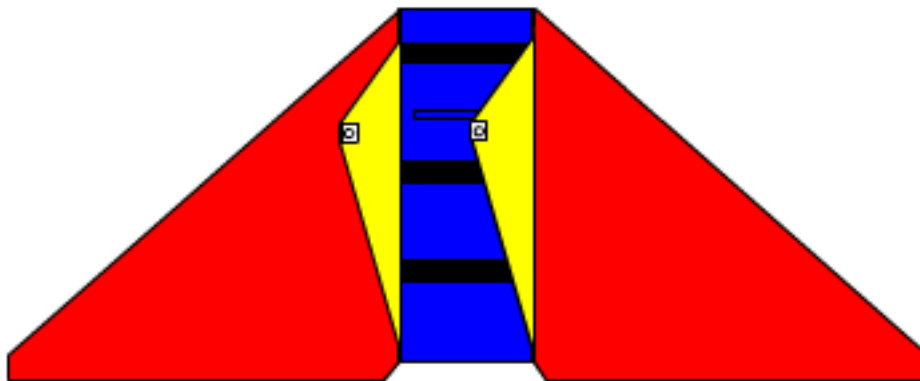

Style 2

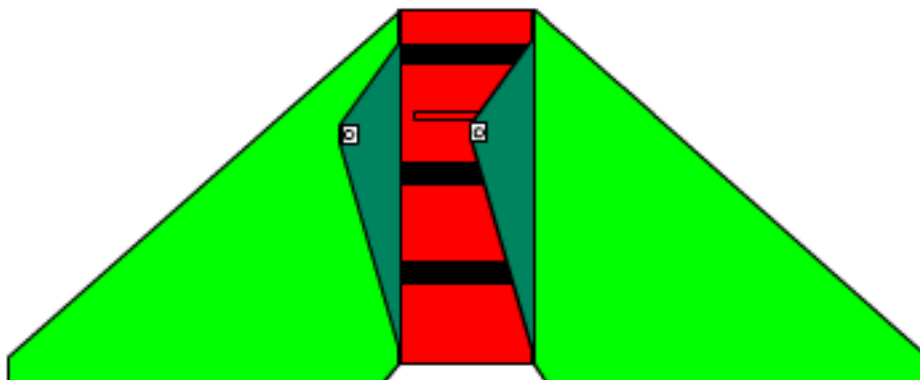

Style 3

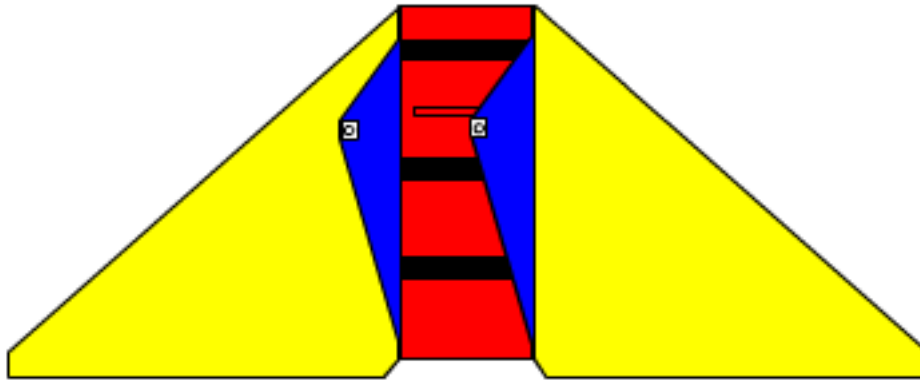

Style 4

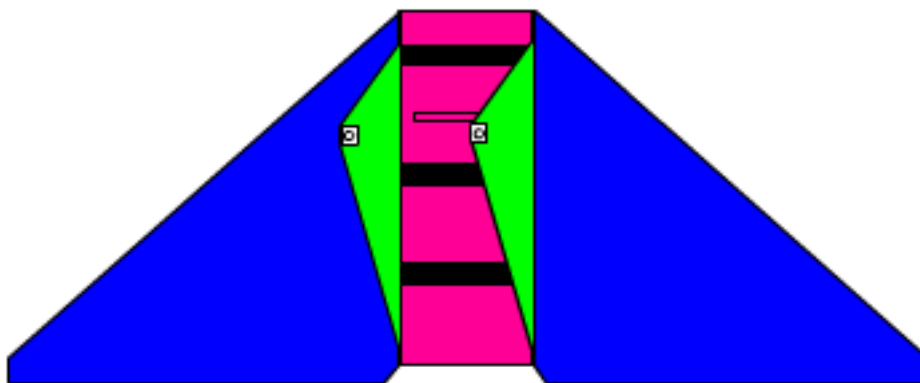

Style 5

Panel 1												
Panel 2												
Panel 3												
Panel 4												

Customised Styles

Choose your own colour combinations for the Skymonster and we will make the kite for you!

Go to our website www.hiflykites.co.za, navigate to "Kite Shop" and find the Skymonster online - you will see there a facility to choose colours (customised style).

Click [here](#)

Pictures of Skymonster



The pictures below illustrate a flying Skymaster - a smaller version of Skymonster. The difference is in size (210cm x 82cm vs. 280cm x 100cm) and frame (Dowel vs. Carbon Fibre)















You can buy a Skymonster online right now at www.hiflykites.co.za. See you there!

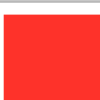

Colour Names, Codes and References

The page contains the closest references to the fabric colours used by Hi Fly Kites. Please note that the fabrics are semi-transparent and the colour perception is different in daylight or artificial light. The page is best viewed in 32-bit (true colour) screen settings.

Swatch	Colour Name	Hi Fly Kites Code	R	G	B	Hue	Sat	Lum	Value (HEX)
	Black	bl	0	0	0	160	0	0	000000
	Bright Blue	bb	3	158	192	127	233	92	039EC0
	Cerese	ce	254	62	97	233	238	149	FE3E61
	Green	gr	84	217	141	97	153	142	54D98D
	Jade	ja	0	123	118	118	240	58	007B76
	Petunia	pe	186	76	106	229	106	123	BA4C6A
	Purple	pu	116	65	118	198	70	86	744176
	Orange	or	254	51	43	2	238	140	FE332B
	Red	re	254	5	0	1	240	120	FE0500
	Royal Blue	rb	58	57	119	161	85	83	3A3977
	Yellow	ye	253	231	80	35	235	157	FDE750
	White	wh	255	255	255	160	0	240	FFFFFF